



Surge protection for public address systems

White Paper



Contents

- Surge protection for a public address system
- Structure with horn loudspeaker with and without lightning protection system

Surge protection for public address systems

White Paper



Public address systems are used for voice, music and alarm transmission. To this end, the useful signal is modulated onto a carrier voltage (e.g. 100 V) and reaches the loudspeaker via a transmitter. This transmitter transforms the low impedance of the loudspeaker to a higher value, thus reducing the current.

Therefore, telecommunication lines with a diameter of 0.8 mm can be used.

There are different kinds of loudspeakers. Flush and wall loudspeakers typically have a rated power between 6 and 30 W, column loudspeakers between 20 W and 100 W and horn loud-

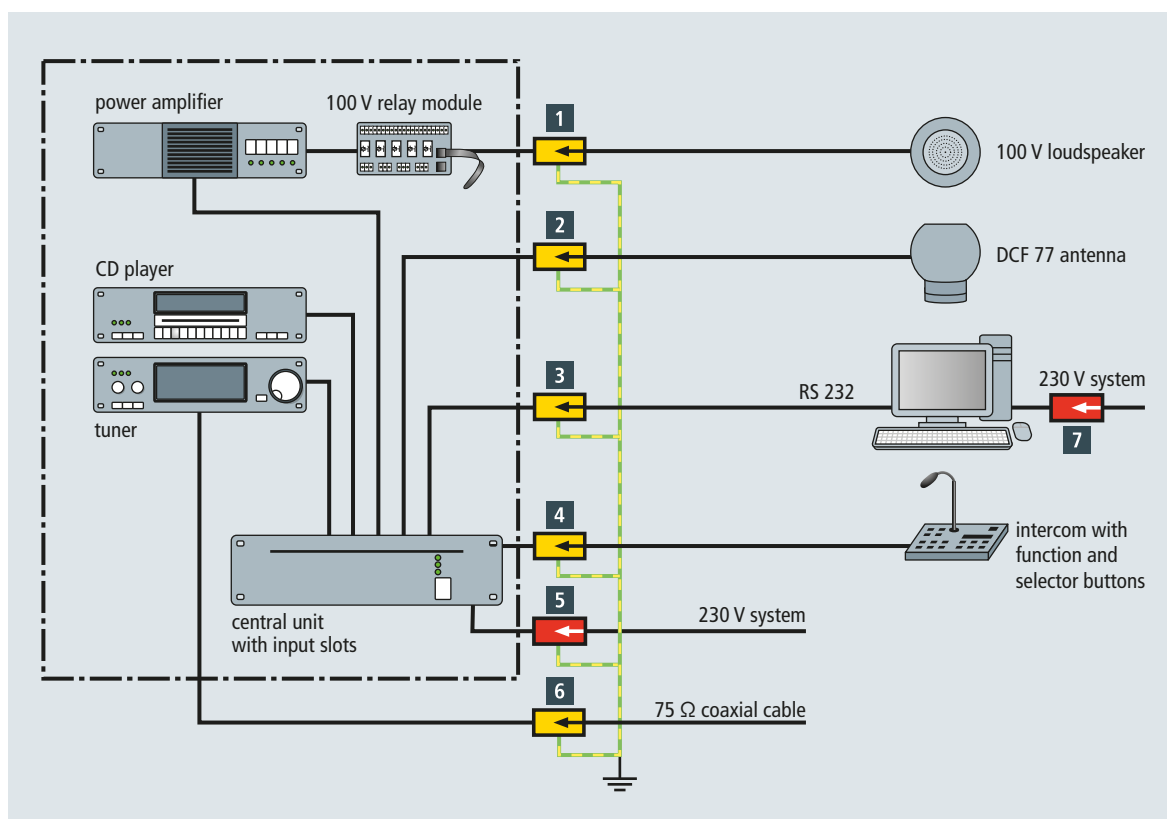

	Type	Info	Part No.
1	DVR 2 BY S 150 FM or BXT ML4 BD 180 + BXT BAS or BSP M2 BD 180 + BXT BAS	(I < 10 A) (I < 0.75 A) (I < 0.75 A)	928 430 920 347 + 920 300 926 247 + 920 300
2	DGA G BNC or DGA G SMA		929 042 929 039
3	BXT ML4 BE 12 + BXT BAS BSP M4 BE 12 + BXT BAS	(I < 0.75 A) (I < 0.75 A)	920 322 + 920 300 926 322 + 920 300
4	BXT ML2 BD HFS 5 + BXT BAS or BSP M2 BD HF 5 + BXT BAS	(I < 1 A) (I < 1 A)	920 271 + 920 300 926 271 + 920 300
5	DR M 2 P 255		953 200
6	DGA FF TV		909 703
7	DPRO 230		909 230

Figure 1 Modular public address system with surge protective devices

Surge protection for public address systems

White Paper



	Type	Info	Part No.
1	DVR 2 BY S 150 FM or	($I < 10 \text{ A}$)	928 430
	DGA G SMA or	-	929 039
	BSP M2 BD 180	($I < 0.75 \text{ A}$)	926 247
	+ BXT BAS		920 300

Figure 2 Horn loudspeaker installed on a structure without external lightning protection system

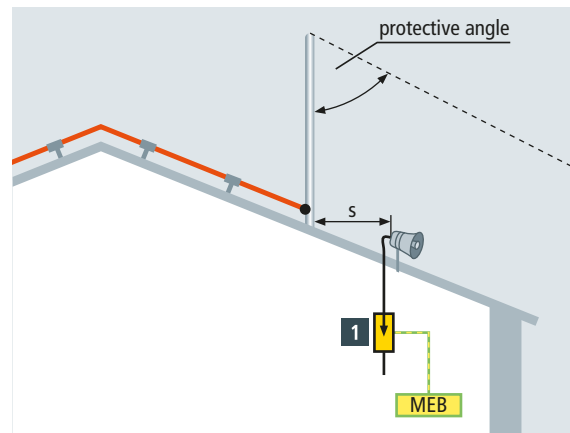

	Type	Info	Part No.
1	DVR 2 BY S 150 FM or	($I < 10 \text{ A}$)	928 430
	DGA G SMA or	-	929 039
	BSP M2 BD 180	($I < 0.75 \text{ A}$)	926 247
	+ BXT BAS		920 300

Figure 3 Horn loudspeaker located in the protected volume of an air-termination system on a structure with external lightning protection system

speakers between 10 W and 60 W. Modular amplifiers have a rated power between 100 W and 600 W (in some cases even higher).

Loudspeakers with different power ratings can be jointly used in a line or group. The minimum power of the amplifier is the sum of the individual loudspeaker power ratings in the public address system. When determining the minimum power of the amplifier, it is not the sum of the loudspeaker power ratings which is decisive, but the sum of the selected power ratings at the transmitters.

Subsection 7.2.1 of the EN 50174-2 standard deals with the protection from lightning strikes and induced surges. It also weighs up the risk of damage against the risk accepted by the operator. If this risk assessment reveals that lightning and surge protection measures are required, lightning and impulse current carrying protective devices must be installed for the relevant installations and systems in need of protection.

The following description makes no reference to any further regulations which may apply (e.g. German Sample Directive on Fireproofing Requirements for Line Systems (MLAR), building regulations, regulations concerning electroacoustic emergency warning systems, regulations concerning burglar and fire alarm systems).

Large-scale public address systems feature a modular 19" design (Figure 1) and are frequently in close proximity to a permanently manned workstation. In such cases, the length of the connecting cable to the PC or intercom dictates whether the surge arresters shown (3 + 4) must be installed. Surge protective devices are required with cable lengths >10 m.

To be able to dimension the surge arrester for the loudspeaker line, the maximum current I in the relevant branch must be determined by means of the ratio $I = P/U$ where P is the power of the amplifier or loudspeaker (group) and U is the carrier voltage.

All earth connections of the surge arresters in the vicinity of the public address system must be connected to a nearby common potential point.

If exterior loudspeakers are located on the roof of a building, they can be damaged by indirect lightning effects (inductive / capacitive coupling) regardless of whether the system has external lightning protection (Figure 3) or not (Figure 2). If the system is equipped with an external lightning protection system (Figure 3), the exterior loudspeaker is reliably protected from direct lightning strikes when located within the protected volume of an air-termination system.

DEHNrail

DR M 2P 255 (953 200)

- Two-pole surge arrester consisting of a base part and a plug-in protection module
- High discharge capacity due to heavy-duty zinc oxide varistor / spark gap combination
- Energy coordination with other arresters of the Red/Line product family



Figure without obligation

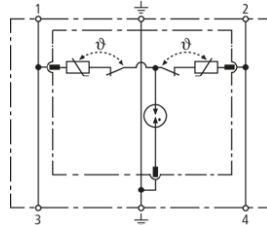

Basic circuit diagram DR M 2P 255

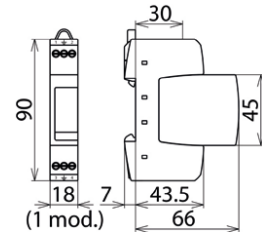

Dimension drawing DR M 2P 255

Two-pole surge arrester consisting of a base part and a plug-in protection module.

Type	DR M 2P 255
Part No.	953 200
SPD according to EN 61643-11 / IEC 61643-11	type 3 / class III
Nominal voltage (a.c.) (U_N)	230 V (50 / 60 Hz)
Max. continuous operating voltage (a.c.) (U_C)	255 V (50 / 60 Hz)
Max. continuous operating voltage (d.c.) (U_C)	255 V
Nominal load current (a.c.) (I_L)	25 A
Nominal discharge current (8/20 μ s) (I_n)	3 kA
Total discharge current (8/20 μ s) [L+N-PE] (I_{total})	5 kA
Combination wave (U_{OC})	6 kV
Combination wave [L+N-PE] ($U_{OC total}$)	10 kV
Voltage protection level [L-N] / [L/N-PE] (U_P)	≤ 1250 / ≤ 1500 V
Response time [L-N] (t_A)	≤ 25 ns
Response time [L/N-PE] (t_A)	≤ 100 ns
Max. mains-side overcurrent protection	25 A gG or B 25 A
Short-circuit withstand capability for mains-side overcurrent protection with 25 A gG (I_{SCCR})	6 kA _{rms}
Temporary overvoltage (TOV) [L-N] (U_T) – Characteristic	335 V / 5 sec. – withstand
Temporary overvoltage (TOV) [L-N] (U_T) – Characteristic	440 V / 120 min. – safe failure
Temporary overvoltage (TOV) [L/N-PE] (U_T) – Characteristic	335 V / 120 min. – withstand
Temporary overvoltage (TOV) [L/N-PE] (U_T) – Characteristic	440 V / 5 sec. – withstand
Temporary overvoltage (TOV) [L+N-PE] (U_T) – Characteristic	1200 V + U_{REF} / 200 ms – safe failure
Operating temperature range (T_U)	-40 °C ... +80 °C
Operating state / fault indication	green / red
Number of ports	1
Cross-sectional area (min.)	0.5 mm ² solid / flexible
Cross-sectional area (max.)	4 mm ² solid / 2.5 mm ² flexible
For mounting on	35 mm DIN rails acc. to EN 60715
Enclosure material	thermoplastic, red, UL 94 V-0
Place of installation	indoor installation
Degree of protection	IP 20
Capacity	1 module(s), DIN 43880
Approvals	KEMA, VDE, UL, CSA
Weight	81 g
Customs tariff number (Comb. Nomenclature EU)	85363030
GTIN	4013364108301
PU	1 pc(s)

DEHNprotector

DPRO 230 (909 230)

- Surge protection with monitoring device and disconnecter
- Visual operating state (green) and fault indication (red)
- Enhanced safety due to fault-proof Y protective circuit



Figure without obligation

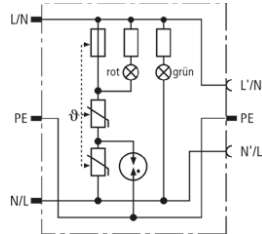

Basic circuit diagram DPRO 230

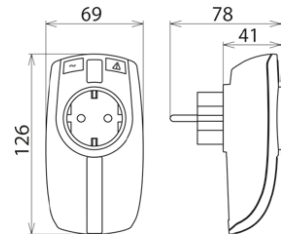

Dimension drawing DPRO 230

Adapter with integrated surge protection and child lock.

Type	DPRO 230
Part No.	909 230
SPD according to EN 61643-11 / IEC 61643-11	type 3 / class III
Nominal voltage (a.c.) (U_N)	230 V (50 / 60 Hz)
Max. continuous operating voltage (a.c.) (U_C)	255 V (50 / 60 Hz)
Nominal load current (a.c.) (I_L)	16 A
Nominal discharge current (8/20 μ s) (I_n)	3 kA
Total discharge current (8/20 μ s) [L+N-PE] (I_{total})	5 kA
Combination wave (U_{OC})	6 kV
Combination wave [L+N-PE] ($U_{OC total}$)	10 kV
Voltage protection level [L-N] / [L/N-PE] (U_P)	≤ 1250 / ≤ 1500 V
Response time [L-N] (t_A)	≤ 25 ns
Response time [L/N-PE] (t_A)	≤ 100 ns
Max. mains-side overcurrent protection	B 16 A
Short-circuit withstand capability for max. mains-side overcurrent protection (I_{SCCR})	1 kA _{rms}
Temporary overvoltage (TOV) [L-N] (U_T) – Characteristic	335 V / 5 sec. – withstand
Temporary overvoltage (TOV) [L-N] (U_T) – Characteristic	440 V / 120 min. – safe failure
Temporary overvoltage (TOV) [L/N-PE] (U_T) – Characteristic	335 V / 120 min. – withstand
Temporary overvoltage (TOV) [L/N-PE] (U_T) – Characteristic	440 V / 5 sec. – withstand
Temporary overvoltage (TOV) [L+N-PE] (U_T) – Characteristic	1200 V + U_{REF} / 200 ms – safe failure
Fault indication	red light
Operating state indication	green light
Number of ports	1
Operating temperature range (T_U)	-25 °C ... +40 °C
For mounting on	earthed socket outlets DIN 49440 / DIN 49441
Enclosure material	thermoplastic, pure white, UL 94 V-2
Place of installation	indoor installation
Degree of protection	IP 20
Dimensions	126 x 69 x 41 mm
Weight	190 g
Customs tariff number (Comb. Nomenclature EU)	85363010
GTIN	4013364117686
PU	1 pc(s)

DEHNvario

DVR 2 BY S 150 FM (928 430)

- For electroacoustic systems up to 10 A
- Direct plug-in technology allows connection without tools
- For installation in conformity with the lightning protection zone concept at the boundaries $0_A - 2$ and higher



Figure without obligation

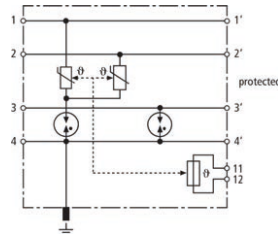

Basic circuit diagram DVR 2 BY S 150 FM

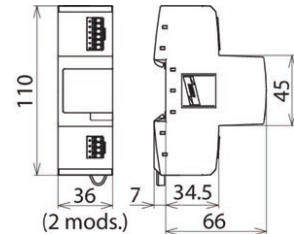

Dimension drawing DVR 2 BY S 150 FM

Compact combined arrester for protecting electroacoustic systems (e.g. voice alarm systems, loudspeaker systems). Protection of one galvanically isolated pair; direct or indirect shield earthing. Direct plug-in technology allows fast conductor connection without tools. Easy replacement of the arrester is ensured by the integrated terminal units which can be released and then removed from the enclosure. Integrated remote signalling contact (break contact).

Technical data

Type	DVR 2 BY S 150 FM
Part No.	928 430
SPD class	TYPE 1P2
Nominal voltage (a.c.) (U_N)	100 V
Max. continuous operating voltage (d.c.) (U_C)	150 V
Max. continuous operating voltage (a.c.) (U_C)	110 V
Nominal current at 70 °C (I_L)	10 A
Nominal current at 80 °C (I_L)	7 A
D1 Lightning impulse current (10/350 μ s) per line (I_{imp})	2.5 kA
D1 Total lightning impulse current (10/350 μ s) (I_{imp})	9 kA
C2 Nominal discharge current (8/20 μ s) per line (I_n)	7.5 kA
C2 Total nominal discharge current (8/20 μ s) (I_n)	22.5 kA
Voltage protection level line-line at I_{imp} D1 (U_p)	≤ 500 V
Voltage protection level line-PG at I_{imp} D1 (U_p)	≤ 700 V
Voltage protection level line-line at 1 kV/ μ s C3 (U_p)	≤ 400 V
Voltage protection level line-PG at 1 kV/ μ s C3 (U_p)	≤ 650 V
Cut-off frequency line-line (f_c)	1.4 MHz
Operating temperature range (T_U)	-40 °C ... +80 °C
Degree of protection	IP 20
Capacity	2 module(s), DIN 43880
For mounting on	35 mm DIN rails acc. to EN 60715
Connection (input / output)	spring / spring
Cross-sectional area, solid	0.2-1.5 mm ²
Cross-sectional area, flexible	0.2-1.5 mm ²
Earthing via	DIN rail
Enclosure material	thermoplastic, UL 94 V-0
Colour	yellow
Test standards	IEC 61643-21 / EN 61643-21
Approvals	EAC
Type of remote signalling contact	break contact
Switching capacity (d.c.)	250 V / 0.1 A; 125 V / 0.2 A; 75 V / 0.5 A
Switching capacity (a.c.)	250 V / 0.5 A
Cross-sectional area for remote signalling terminals	max. 1.5 mm ²
Weight	110 g
Customs tariff number (Comb. Nomenclature EU)	85363010
GTIN	4013364261389
PU	1 pc(s)

BLITZDUCTOR SP

BSP M2 BD 180 (926 247)

- High degree of protection for one pair
- For installation in conformity with the lightning protection zone concept at the boundaries from $0_B - 2$ and higher



Figure without obligation

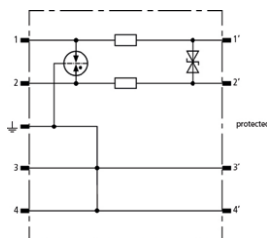

Basic circuit diagram BSP M2 BD 180

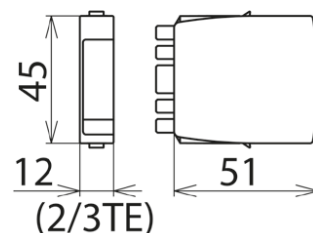

Dimension drawing BSP M2 BD 180

Space-saving surge arrester module for protecting one pair of balanced interfaces with galvanic isolation.

Type	BSP M2 BD 180
Part No.	926 247
SPD class	TYPE 2P2
Nominal voltage (U_N)	180 V
Max. continuous operating voltage (d.c.) (U_C)	180 V
Max. continuous operating voltage (a.c.) (U_C)	127 V
Nominal current at 45 °C (I_L)	0.75 A
D1 Lightning impulse current (10/350 μ s) per line (I_{imp})	1 kA
C2 Total nominal discharge current (8/20 μ s) (I_n)	20 kA
C2 Nominal discharge current (8/20 μ s) per line (I_n)	10 kA
Voltage protection level line-line for I_n C2 (U_p)	≤ 270 V
Voltage protection level line-PG for I_n C2 (U_p)	≤ 600 V
Voltage protection level line-line at 1 kV/ μ s C3 (U_p)	≤ 250 V
Voltage protection level line-PG at 1 kV/ μ s C3 (U_p)	≤ 550 V
Series impedance per line	1.8 ohm(s)
Cut-off frequency line-line (f_c)	25.0 MHz
Capacitance line-line (C)	≤ 240 pF
Capacitance line-PG (C)	≤ 16 pF
Operating temperature range (T_U)	-40 °C ... +80 °C
Degree of protection (with plugged-in protection module)	IP 20
Pluggable into	BXT BAS / BSP BAS 4 base part
Earthing via	BXT BAS / BSP BAS 4 base part
Enclosure material	polyamide PA 6.6
Colour	yellow
Test standards	IEC 61643-21, UL 497B
Approvals	UL, CSA, SIL, EAC
SIL classification	up to SIL3 *)
Weight	21 g
Customs tariff number (Comb. Nomenclature EU)	85363010
GTIN	4013364127128
PU	1 pc(s)

*) For more detailed information, please visit www.dehn-international.com.

BLITZDUCTOR SP

BSP M2 BD HF 5 (926 271)

- Minimal signal interference
- For installation in conformity with the lightning protection zone concept at the boundaries from 0_B-2 and higher



Figure without obligation

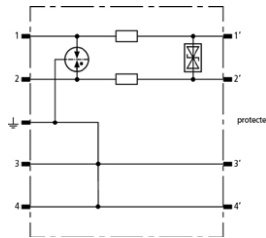

Basic circuit diagram BSP M2 BD HF 5

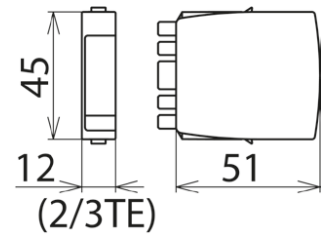

Dimension drawing BSP M2 BD HF 5

Space-saving surge arrester module for protecting one pair of high-frequency bus systems or video transmission systems with galvanic isolation.

Type	BSP M2 BD HF 5
Part No.	926 271
SPD class	TYPE 2 P1
Nominal voltage (U_N)	5 V
Max. continuous operating voltage (d.c.) (U_C)	6.0 V
Max. continuous operating voltage (a.c.) (U_C)	4.2 V
Nominal current at 45 °C (I_L)	1.0 A
D1 Lightning impulse current (10/350 μ s) per line (I_{imp})	1 kA
C2 Total nominal discharge current (8/20 μ s) (I_n)	20 kA
C2 Nominal discharge current (8/20 μ s) per line (I_n)	10 kA
Voltage protection level line-line for I_n C2 (U_p)	≤ 35 V
Voltage protection level line-PG for I_n C2 (U_p)	≤ 600 V
Voltage protection level line-line at 1 kV/ μ s C3 (U_p)	≤ 11 V
Voltage protection level line-PG at 1 kV/ μ s C3 (U_p)	≤ 550 V
Series impedance per line	1.0 ohm(s)
Cut-off frequency line-line (f_c)	100 MHz
Capacitance line-line (C)	≤ 25 pF
Capacitance line-PG (C)	≤ 25 pF
Operating temperature range (T_U)	-40 °C ... +80 °C
Degree of protection (with plugged-in protection module)	IP 20
Pluggable into	BXT BAS / BSP BAS 4 base part
Earthing via	BXT BAS / BSP BAS 4 base part
Enclosure material	polyamide PA 6.6
Colour	yellow
Test standards	IEC 61643-21, UL 497B
Approvals	UL, CSA, SIL, EAC
SIL classification	up to SIL3 *)
Weight	21 g
Customs tariff number (Comb. Nomenclature EU)	85363010
GTIN	4013364127142
PU	1 pc(s)

*) For more detailed information, please visit www.dehn-international.com.

BLITZDUCTOR SP

BSP M4 BE 12 (926 322)

- High degree of protection for four single lines
- For installation in conformity with the lightning protection zone concept at the boundaries from $0_B - 2$ and higher



Figure without obligation

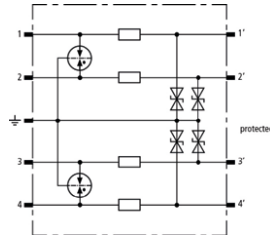

Basic circuit diagram BSP M4 BE 12

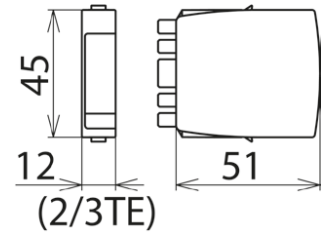

Dimension drawing BSP M4 BE 12

Space-saving surge arrester module for protecting four single lines sharing a common reference potential and unbalanced interfaces.

Type Part No.	BSP M4 BE 12 926 322
SPD class	TYPE 2 P1
Nominal voltage (U_N)	12 V
Max. continuous operating voltage (d.c.) (U_C)	15 V
Max. continuous operating voltage (a.c.) (U_C)	10.6 V
Nominal current at 45 °C (I_L)	0.75 A
D1 Lightning impulse current (10/350 μ s) per line (I_{imp})	1 kA
C2 Total nominal discharge current (8/20 μ s) (I_n)	20 kA
C2 Nominal discharge current (8/20 μ s) per line (I_n)	10 kA
Voltage protection level line-line for I_n C2 (U_p)	≤ 55 V
Voltage protection level line-PG for I_n C2 (U_p)	≤ 60 V
Voltage protection level line-line at 1 kV/ μ s C3 (U_p)	≤ 38 V
Voltage protection level line-PG at 1 kV/ μ s C3 (U_p)	≤ 19 V
Series impedance per line	1.8 ohm(s)
Cut-off frequency line-PG (f_c)	2.7 MHz
Capacitance line-line (C)	≤ 1.0 nF
Capacitance line-PG (C)	≤ 2.0 nF
Operating temperature range (T_U)	-40 °C ... +80 °C
Degree of protection (with plugged-in protection module)	IP 20
Pluggable into	BXT BAS / BSP BAS 4 base part
Earthing via	BXT BAS / BSP BAS 4 base part
Enclosure material	polyamide PA 6.6
Colour	yellow
Test standards	IEC 61643-21, UL 497B
Approvals	UL, CSA, SIL, EAC
SIL classification	up to SIL3 *)
Weight	22 g
Customs tariff number (Comb. Nomenclature EU)	85363010
GTIN	4013364127166
PU	1 pc(s)

*) For more detailed information, please visit www.dehn-international.com.

BLITZDUCTOR XT

BXT ML2 BD HFS 5 (920 271)

- LifeCheck SPD monitoring function
- Minimal signal interference
- For installation in conformity with the lightning protection zone concept at the boundaries from $0_A -2$ and higher



Figure without obligation

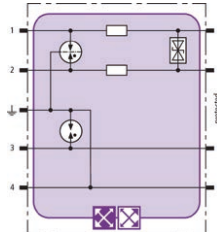

Basic circuit diagram BXT ML2 BD HFS

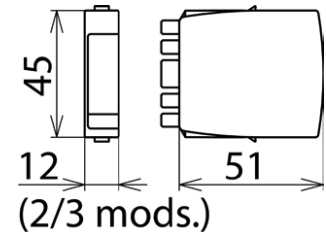

Dimension drawing BXT ML2 BD HFS

Space-saving combined lightning current and surge arrester module with LifeCheck feature for protecting one pair of unearthed high-frequency bus systems or video transmission systems, with direct or indirect shield earthing. If LifeCheck detects thermal or electrical overload, the arrester has to be replaced. This status is indicated contactlessly by the DEHNrecord LC / SCM / MCM reader.

Type	BXT ML2 BD HFS 5
Part No.	920 271
SPD monitoring system	LifeCheck
SPD class	TYPE 1 PE
Nominal voltage (U_N)	5 V
Max. continuous operating voltage (d.c.) (U_C)	6.0 V
Max. continuous operating voltage (a.c.) (U_C)	4.2 V
Nominal current at 45 °C (I_L)	1.0 A
D1 Total lightning impulse current (10/350 μ s) (I_{imp})	9 kA
D1 Lightning impulse current (10/350 μ s) per line (I_{imp})	2.5 kA
C2 Total nominal discharge current (8/20 μ s) (I_n)	20 kA
C2 Nominal discharge current (8/20 μ s) per line (I_n)	10 kA
Voltage protection level line-line for I_{imp} D1 (U_p)	≤ 25 V
Voltage protection level line-PG for I_{imp} D1 (U_p)	≤ 550 V
Voltage protection level line-line at 1 kV/ μ s C3 (U_p)	≤ 11 V
Voltage protection level line-PG at 1 kV/ μ s C3 (U_p)	≤ 550 V
Series resistance per line	1.0 ohm(s)
Cut-off frequency line-line (f_c)	100.0 MHz
Capacitance line-line (C)	≤ 25 pF
Capacitance line-PG (C)	≤ 25 pF
Operating temperature range (T_U)	-40 °C ... +80 °C
Degree of protection (with plugged-in protection module)	IP 20
Pluggable into	BXT BAS / BSP BAS 4 base part
Earthing via	BXT BAS / BSP BAS 4 base part
Enclosure material	polyamide PA 6.6
Colour	yellow
Test standards	IEC 61643-21 / EN 61643-21, UL 497B
Approvals	CSA, UL, EAC, ATEX, IECEx, CSA & USA Hazloc, SIL
SIL classification	up to SIL3 ^{*)}
ATEX approvals	DEKRA 11ATEX0089 X: II 3 G Ex nA IIC T4 Gc
IECEx approvals	DEK 11.0032X: Ex nA IIC T4 Gc
CSA & USA Hazloc approvals (1)	2516389: Class I Div. 2 GP A, B, C, D T4
CSA & USA Hazloc approvals (2)	2516389: Class I Zone 2, AEx nA IIC T4
Weight	22 g
Customs tariff number (Comb. Nomenclature EU)	85363010
GTIN	4013364117556
PU	1 pc(s)

^{*)} For more detailed information, please visit www.dehn-international.com.

BLITZDUCTOR XT

BXT ML4 BE 12 (920 322)

- LifeCheck SPD monitoring function
- Optimal protection of four single lines
- For installation in conformity with the lightning protection zone concept at the boundaries from $0_A - 2$ and higher



Figure without obligation

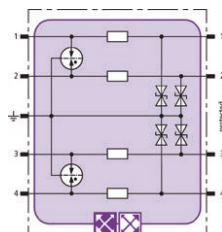

Basic circuit diagram BXT ML4 BE 12

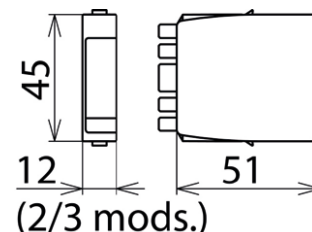

Dimension drawing BXT ML4 BE 12

Space-saving combined lightning current and surge arrester module with LifeCheck feature for protecting four single lines sharing a common reference potential as well as unbalanced interfaces. If LifeCheck detects thermal or electrical overload, the arrester has to be replaced. This status is indicated contactlessly by the DEHNrecord LC / SCM / MCM reader.

Type Part No.	BXT ML4 BE 12 920 322
SPD monitoring system	LifeCheck
SPD class	TYPE 1 Pt
Nominal voltage (U_N)	12 V
Max. continuous operating voltage (d.c.) (U_C)	15 V
Max. continuous operating voltage (a.c.) (U_C)	10.6 V
Nominal current at 45 °C (I_L)	0.75 A
D1 Total lightning impulse current (10/350 μ s) (I_{imp})	10 kA
D1 Lightning impulse current (10/350 μ s) per line (I_{imp})	2.5 kA
C2 Total nominal discharge current (8/20 μ s) (I_n)	20 kA
C2 Nominal discharge current (8/20 μ s) per line (I_n)	10 kA
Voltage protection level line-line for I_{imp} D1 (U_p)	≤ 50 V
Voltage protection level line-PG for I_{imp} D1 (U_p)	≤ 37 V
Voltage protection level line-line at 1 kV/ μ s C3 (U_p)	≤ 38 V
Voltage protection level line-PG at 1 kV/ μ s C3 (U_p)	≤ 19 V
Series resistance per line	1.8 ohm(s)
Cut-off frequency line-PG (f_c)	2.7 MHz
Capacitance line-line (C)	≤ 1.0 nF
Capacitance line-PG (C)	≤ 2.0 nF
Operating temperature range (T_U)	-40 °C ... +80 °C
Degree of protection (with plugged-in protection module)	IP 20
Pluggable into	BXT BAS / BSP BAS 4 base part
Earthing via	BXT BAS / BSP BAS 4 base part
Enclosure material	polyamide PA 6.6
Colour	yellow
Test standards	IEC 61643-21 / EN 61643-21, UL 497B
Approvals	CSA, UL, EAC, ATEX, IECEx, CSA & USA Hazloc, SIL
SIL classification	up to SIL3 ^{*)}
ATEX approvals	DEKRA 11ATEX0089 X: II 3 G Ex nA IIC T4 Gc
IECEx approvals	DEK 11.0032X: Ex nA IIC T4 Gc
CSA & USA Hazloc approvals (1)	2516389: Class I Div. 2 GP A, B, C, D T4
CSA & USA Hazloc approvals (2)	2516389: Class I Zone 2, AEx nA IIC T4
Weight	24 g
Customs tariff number (Comb. Nomenclature EU)	85363010
GTIN	4013364109049
PU	1 pc(s)

^{*)} For more detailed information, please visit www.dehn-international.com.

BLITZDUCTOR XT

BXT ML4 BD 180 (920 347)

- LifeCheck SPD monitoring function
- Optimal protection of two pairs
- For installation in conformity with the lightning protection zone concept at the boundaries from $0_A -2$ and higher



Figure without obligation

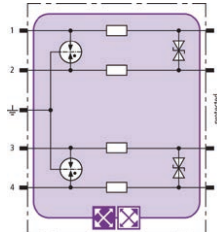

Basic circuit diagram BXT ML4 BD 180

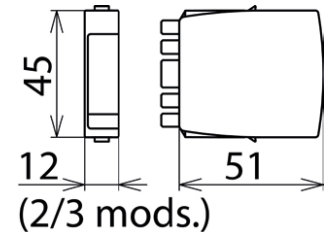

Dimension drawing BXT ML4 BD 180

Space-saving combined lightning current and surge arrester module with LifeCheck feature for protecting two pairs of unearthed balanced interfaces. If LifeCheck detects thermal or electrical overload, the arrester has to be replaced. This status is indicated contactlessly by the DEHNrecord LC / SCM / MCM reader.

Type	BXT ML4 BD 180
Part No.	920 347
SPD monitoring system	LifeCheck
SPD class	TYPE 1P2
Nominal voltage (U_N)	180 V
Max. continuous operating voltage (d.c.) (U_c)	180 V
Max. continuous operating voltage (a.c.) (U_c)	127 V
Nominal current at 45 °C (I_L)	0.75 A
D1 Total lightning impulse current (10/350 μ s) (I_{imp})	10 kA
D1 Lightning impulse current (10/350 μ s) per line (I_{imp})	2.5 kA
C2 Total nominal discharge current (8/20 μ s) (I_n)	20 kA
C2 Nominal discharge current (8/20 μ s) per line (I_n)	10 kA
Voltage protection level line-line for I_{imp} D1 (U_p)	≤ 270 V
Voltage protection level line-PG for I_{imp} D1 (U_p)	≤ 550 V
Voltage protection level line-line at 1 kV/ μ s C3 (U_p)	≤ 250 V
Voltage protection level line-PG at 1 kV/ μ s C3 (U_p)	≤ 550 V
Series resistance per line	1.8 ohm(s)
Cut-off frequency line-line (f_c)	25.0 MHz
Capacitance line-line (C)	≤ 240 pF
Capacitance line-PG (C)	≤ 16 pF
Operating temperature range (T_U)	-40 °C ... +80 °C
Degree of protection (with plugged-in protection module)	IP 20
Pluggable into	BXT BAS / BSP BAS 4 base part
Earthing via	BXT BAS / BSP BAS 4 base part
Enclosure material	polyamide PA 6.6
Colour	yellow
Test standards	IEC 61643-21 / EN 61643-21, UL 497B
Approvals	CSA, UL, EAC, ATEX, IECEx, CSA & USA Hazloc, SIL
SIL classification	up to SIL3 [*]
ATEX approvals	DEKRA 11ATEX0089 X: II 3 G Ex nA IIC T4 Gc
IECEx approvals	DEK 11.0032X: Ex nA IIC T4 Gc
CSA & USA Hazloc approvals (1)	2516389: Class I Div. 2 GP A, B, C, D T4
CSA & USA Hazloc approvals (2)	2516389: Class I Zone 2, AEx nA IIC T4
Weight	24 g
Customs tariff number (Comb. Nomenclature EU)	85363010
GTIN	4013364109018
PU	1 pc(s)

^{*}For more detailed information, please visit www.dehn-international.com.

BLITZDUCTOR

BXT BAS (920 300)

- Four-pole version for universal use with all types of BSP and BXT / BXTU protection modules
- No signal interruption if the protection module is removed
- Universal design without protection elements



Figure without obligation

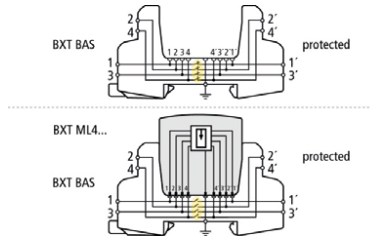

Basic circuit diagram with and without plugged-in module

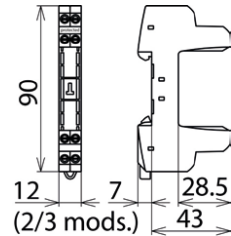

Dimension drawing BXT BAS

The BLITZDUCTOR XT base part is an extremely space-saving and universal four-pole feed-through terminal for the insertion of a protection module without signal disconnection if the protection module is removed. The snap-in mechanism at the supporting foot of the base part allows the protection module to be safely earthed via the DIN rail. Since no components of the protective circuit are situated in the base part, maintenance is only required for the protection modules.

Type Part No.	BXT BAS 920 300
Operating temperature range (T _U)	-40 °C ... +80 °C
Degree of protection	IP 20
For mounting on	35 mm DIN rails acc. to EN 60715
Connection (input / output)	screw / screw
Signal disconnection	no
Cross-sectional area, solid	0.08-4 mm ²
Cross-sectional area, flexible	0.08-2.5 mm ²
Tightening torque (terminals)	0.4 Nm
Earthing via	35 mm DIN rails acc. to EN 60715
Enclosure material	polyamide PA 6.6
Colour	yellow
ATEX approvals	DEKRA 11ATEX0089 X: II 3 G Ex nA IIC T4 Gc ^{*)}
IECEX approvals	DEK 11.0032X: Ex nA IIC T4 Gc ^{*)}
Approvals	CSA, UL, EAC, ATEX, IECEx ^{*)}
Weight	34 g
Customs tariff number (Comb. Nomenclature EU)	85369010
GTIN	4013364109179
PU	1 pc(s)

^{*)} only in connection with an approved protection module

DEHNgate

DGA FF TV (909 703)

- Frequency range for analogue and digital TV, also suitable for reverse LAN channels
- Arresters of type FF and GFF with integrated measuring output
- Three types for adapted use in conformity with the lightning protection zone concept at the boundaries from $0_A - 2$ (combined lightning current and surge arresters of type GFF), $0_A - 1$ (lightning current arresters of type GF) and $1 - 2$ (surge arresters of type FF)



Figure without obligation

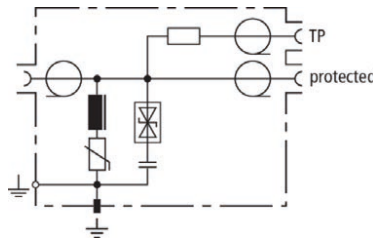

Basic circuit diagram DGA FF TV

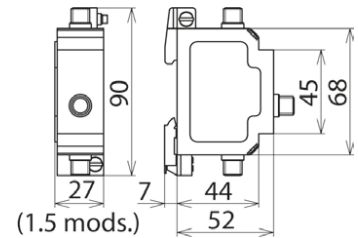

Dimension drawing DGA FF TV

DGA ... TV arresters with F connection for remote supply protect 75-ohm satellite and broadband cable systems and fulfil the high shielding requirements of class A according to EN 50083-2. They allow space-saving installation in all common TV and satellite applications and are available as lightning current arresters, surge arresters as well as combined lightning current and surge arresters with integrated measuring output, allowing the system to be easily tested.

Type	DGA FF TV
Part No.	909 703
SPD class	TYPE 3 P1
Max. continuous operating voltage (d.c.) (U_c)	24 V
Nominal current (I_n)	2 A
D1 Lightning impulse current (10/350 μ s) (I_{imp})	0.2 kA
C2 Nominal discharge current (8/20 μ s) (I_n)	1.5 kA
Voltage protection level for I_{imp} D1 (U_p)	≤ 230 V
Voltage protection level for I_n C2 (U_p)	≤ 300 V
Voltage protection level at 1 kV/ μ s C3 (U_p)	≤ 60 V
Frequency range	d.c. / 5-3000 MHz
Insertion loss 5-862 MHz typ.	1.2 dB
Insertion loss 862-2400 MHz typ.	1.4 dB
Insertion loss 2400-3000 MHz typ.	2 dB
Return loss	≥ 14 dB
Return loss (47-2400 MHz)	≥ 18 dB (-1.5 dB/octave)
Return loss test socket (5-47 MHz)	≥ 18 dB
Test socket connection loss	20 dB
Shield attenuation 5-300 MHz	≥ 85 dB
Shield attenuation 300-470 MHz	≥ 80 dB
Shield attenuation 470-1000 MHz	≥ 75 dB
Shield attenuation 1000-2400 MHz	≥ 55 dB
Characteristic impedance (Z)	75 ohms
Operating temperature range (T_u)	-40 °C ... +80 °C
Degree of protection (if lines are connected)	IP 30
For mounting on	35 mm DIN rails acc. to EN 60715 or wall mounting
Connection (input / output)	F socket / F socket
Earthing via	DIN rail or screw connection
Enclosure material	metal
Colour	bare surface
Test standards	IEC 61643-21 / EN 61643-21
Approvals	EAC
Accessories	2x F plugs
Weight	233 g
Customs tariff number (Comb. Nomenclature EU)	85363010
GTIN	4013364085664
PU	1 pc(s)

DEHNgate

DGA G SMA (929 039)

- Compact dimensions
- Extremely wide transmission range
- For installation in conformity with the lightning protection zone concept at the boundaries from $0_B - 1$ and higher



Figure without obligation

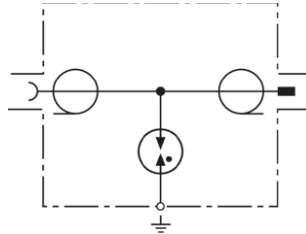

Basic circuit diagram DGA G SMA



Dimension drawing DGA G SMA

Surge arrester for remote supply with integrated gas discharge tube. Ideally suited for wireless applications for the coaxial interfaces of devices and antennas.

Available with SMA, BNC or N connection for bushing installation.

Type Part No.	DGA G SMA 929 039
SPD class	TYPE2
Max. continuous operating voltage (d.c.) (U_c)	135 V
Nominal current (I_n)	2 A
Max. transmission capacity	60 W
D1 Lightning impulse current (10/350 μ s) (I_{imp})	1 kA
C2 Nominal discharge current (8/20 μ s) (I_n)	5 kA
Voltage protection level for I_n C2 (U_p)	≤ 700 V
Frequency range	0-5.8 GHz
Insertion loss	≤ 0.2 dB
Return loss (d.c. - 3 GHz)	≥ 20 dB
Return loss (3 GHz-5.8 GHz)	≥ 18 dB
Characteristic impedance (Z)	50 ohms
Operating temperature range (T_u)	-40 °C ... +85 °C
Degree of protection (if lines are connected)	IP 65
Connection	SMA socket / SMA plug
Earthing via	bushing ($\varnothing 11.2$ mm)
Enclosure material	gold-plated brass
Colour	gold
Test standards	IEC 61643-21 / EN 61643-21
Weight	24 g
Customs tariff number (Comb. Nomenclature EU)	85366910
GTIN	4013364135185
PU	1 pc(s)

DEHNgate

DGA G BNC (929 042)

- Compact dimensions
- Extremely wide transmission range
- For installation in conformity with the lightning protection zone concept at the boundaries from $0_B - 1$ and higher



Figure without obligation

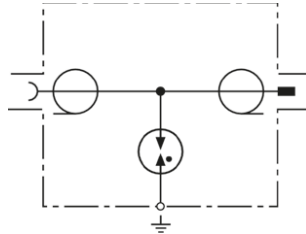

Basic circuit diagram DGA G BNC

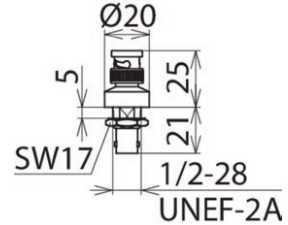

Dimension drawing DGA G BNC

Surge arrester for remote supply with integrated gas discharge tube. Ideally suited for wireless applications for the coaxial interfaces of devices and antennas.

Available with SMA, BNC or N connection for bushing installation.

Type Part No.	DGA G BNC 929 042
SPD class	TYPE2
Max. continuous operating voltage (d.c.) (U_c)	135 V
Nominal current (I_n)	3.5 A
Max. transmission capacity	25 W
D1 Lightning impulse current (10/350 μ s) (I_{imp})	1 kA
C2 Nominal discharge current (8/20 μ s) (I_n)	5 kA
Voltage protection level for I_n C2 (U_p)	≤ 650 V
Frequency range	0-4 GHz
Insertion loss	≤ 0.2 dB
Return loss (d.c. - 3 GHz)	≥ 20 dB
Return loss (3 GHz-4 GHz)	≥ 20 dB
Characteristic impedance (Z)	50 ohms
Operating temperature range (T_u)	-40 °C ... +85 °C
Degree of protection (if lines are connected)	IP 20
Connection	BNC socket / BNC plug
Earthing via	bushing ($\varnothing 12.9$ mm)
Enclosure material	brass, gold-plated
Colour	gold
Test standards	IEC 61643-21 / EN 61643-21
Weight	39 g
Customs tariff number (Comb. Nomenclature EU)	85366910
GTIN	4013364091030
PU	1 pc(s)

Surge Protection
Lightning Protection
Safety Equipment
DEHN protects.

DEHN SE
Hans-Dehn-Str. 1
Postfach 1640
92306 Neumarkt, Germany

Tel. +49 9181 906-0
Fax +49 9181 906-1100
info@dehn.de
www.dehn-international.com



www.dehn-international.com/partners

Type designations of products mentioned in this white paper which are at the same time registered trademarks are not especially marked. Hence the absence of TM or © markings does not indicate that the type designation is a free trade name. Nor can it be seen whether patents or utility models and other intellectual and industrial property rights exist. We reserve the right to introduce changes in performance, configuration and technology, dimensions, weights and materials in the course of technical progress. The figures are shown without obligation. Misprints, errors and modifications excepted. Reproduction in any form whatsoever is forbidden without our authorisation.

Photo "Two horn speakers on a corner" by cbs_fan (http://commons.wikimedia.org/wiki/File:Horn_Speaker.jpg); Licence: CC-BY-SA 2.0 (<http://creativecommons.org/licenses/by-sa/2.0/>)